

NEW

# High Performance Tunable Laser TSL-550

The TSL-550 is a high performance tunable laser with a wide tuning range and an output combining high power and high signal-to-noise ratio. The mod-hop-free tuning TSL-550 is equipped with features such as fine tuning and coherence control making it a must have tool for precision optical testing. Santec has used an innovative cavity design to lower the optical ASE noise, resulting in an extraordinarily high signal-to-noise ratio of over 90dB/0.1nm, while also maintaining a high output power of over +10dBm. GPIB and USB interfaces with the industry standard SCPI command set provide a convenient automated measurement solution.

The TSL-550 has two separate versions: Type A includes a wavelength meter with  $\pm 20\text{pm}$  wavelength accuracy and Type C, the high accuracy version, with an absolute wavelength accuracy of  $\pm 5\text{pm}$ .

The TSL-550 is ideal for next generation components testing driven by innovations in Dense Wavelength Division Multiplexing (DWDM), passives and Wavelength Selective Switches (WSS) that require characterization of multi-input, high extinction ratio devices. The TSL-550 is designed to improve production inspection throughput by doubling the scan repetition rate over conventional lasers. In addition, the TSL-550 is available for WDL and PDL measurement with the support of our power meter, MPM-200 and dedicated software.



## Measurement Data

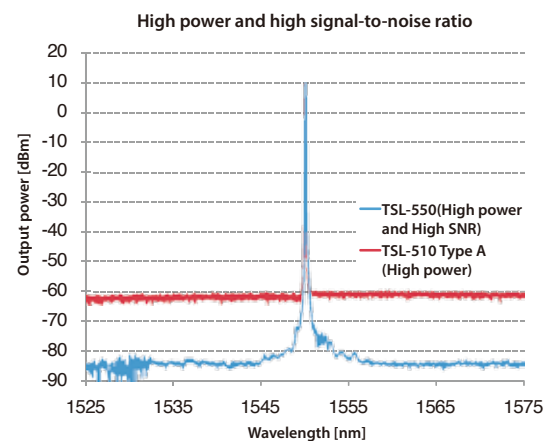

## Features

- ▶ Wide tuning range within 1260-1680nm
- ▶ High output power +10dBm
- ▶ High signal-to-noise ratio 90dB/0.1nm
- ▶ High wavelength accuracy  
(Type A:  $\pm 20\text{pm}$ , Type C:  $\pm 5\text{pm}$ )

## Applications

- ▶ Optical component characterization
- ▶ Fiber optic transmission testing
- ▶ Photonic material characterization
- ▶ Interferometry
- ▶ Optical spectroscopy

# SANTEC TUNABLE LASERS

## Optical Specifications

Wavelength range: 1260-1360nm and 1500-1630nm

Category	Parameter	Unit	Performance		
			TypeA	TypeC	
Wavelength Characteristics	Wavelength Tuning Range	nm	1260-1360 / 1500-1630		
	Wavelength Setting Resolution	pm	0.1		
	Absolute Accuracy <sup>*1</sup>	Operating Temperature	pm	±20	±5
		25±1 degC (typ.)	pm	±15	±2.5
	Repeatability <sup>*1</sup>		pm	±10	±2
	Stability (typ.) <sup>*2</sup>		pm	≤ ±5	≤ ±1
Sweep Speed		nm/sec	1 to 100		
Optical power Characteristics	Output Power	Peak (typ.)	dBm		
		Full Tuning Range	dBm		
	Power Repeatability <sup>*1, *3</sup>		dB		
	Power Stability <sup>*2, *3</sup>		dB		
	Power Flatness vs. Wavelength <sup>*1, *3</sup>		dB		
	Relative Intensity Noise (RIN) (typ.) <sup>*6</sup>		dB/Hz		
Spectrum	Linewidth (typ.)	Coherence Ctrl. Off	kHz	500	200
		Coherence Ctrl. On	MHz	40	
	SMSR (typ.)		dB		
	Signal to Total Source Spontaneous Emission Ratio <sup>*4</sup>		dB		
	Signal to Source Spontaneous Emission Ratio <sup>*5</sup>		dB/nm		

\* All specifications are quoted after 1 hour warm-up period. Specifications apply for wavelengths not equal to any water absorption line.

\*1: At static condition or "Step" sweep mode. \*2: For period of 1 hour. Within ± 0.5 °C. \*3: At "Auto" power mode.

\*4: Ratio of signal power to total spontaneous emission power within ±15nm of the signal wavelength (typical value).

\*5: Ratio of signal power to maximum spontaneous emission power in a 1nm band within a ±3nm band around the signal wavelength (typical value).

\*6: At maximum output power.

Wavelength range: 1355-1485nm and 1480-1630nm

Category	Parameter	Unit	Performance		
			TypeA	TypeC	
Wavelength Characteristics	Wavelength Tuning Range	nm	1355-1485 / 1480-1630		
	Wavelength Setting Resolution	pm	0.1		
	Absolute Accuracy <sup>*1</sup>	Operating Temperature	pm	±20	±5
		25±1 degC (typ.)	pm	±15	±2.5
	Repeatability <sup>*1</sup>		pm	±10	±2
	Stability (typ.) <sup>*2</sup>		pm	≤ ±5	≤ ±1
Sweep Speed		nm/sec	1 to 100		
Optical power Characteristics	Output Power	Peak (typ.)	dBm		
		≥ 10dBm Range	dBm		
		Full Tuning Range	dBm		
	Power Repeatability <sup>*1, *3</sup>		dB		
	Power Stability <sup>*2, *3</sup>		dB		
	Power Flatness vs. Wavelength <sup>*1, *3</sup>		dB		
Relative Intensity Noise (RIN) (typ.) <sup>*6</sup>		dB/Hz			
Spectrum	Linewidth (typ.)	Coherence Ctrl. Off	kHz	500	200
		Coherence Ctrl. On	MHz	40	
	SMSR (typ.)		dB		
	Signal to Total Source Spontaneous Emission Ratio <sup>*4</sup>		dB		
	Signal to Source Spontaneous Emission Ratio <sup>*5</sup>		dB/nm		

\* All specifications are quoted after 1 hour warm-up period. Specifications apply for wavelengths not equal to any water absorption line.

\*1: At static condition or "Step" sweep mode. \*2: For period of 1 hour. Within ± 0.5 °C. \*3: At "Auto" power mode.

\*4: Ratio of signal power to total spontaneous emission power within ±15nm of the signal wavelength (typical value).

\*5: Ratio of signal power to maximum spontaneous emission power in a 1nm band within a ±3nm band around the signal wavelength (typical value).

\*6: At maximum output power.

## Optical Specifications

Wavelength range: 1560-1680nm

Category	Parameter	Unit	Performance		
			TypeA	TypeC	
Wavelength Characteristics	Wavelength Tuning Range	nm	1560-1680		
	Wavelength Setting Resolution	pm	0.1		
	Absolute Accuracy <sup>*1</sup>	Operating Temperature	pm	±20	±5
		25±1 degC (typ.)	pm	±15	±2.5
	Repeatability <sup>*1</sup>		pm	±10	±2
	Stability (typ.) <sup>*2</sup>		pm	≤ ±5	≤ ±1
Sweep Speed		nm/sec	1 to 100		
Optical power Characteristics	Output Power <sup>*7</sup>	Peak (typ.)	dBm		
		Full Tuning Range	dBm		
	Power Repeatability <sup>*1, *3</sup>		dB		
	Power Stability <sup>*2, *3</sup>		dB		
	Power Flatness vs. Wavelength <sup>*1, *3, *7</sup>		dB		
	Relative Intensity Noise (RIN) (typ.) <sup>*6</sup>		dB/Hz		
Spectrum	Linewidth (typ.)	Coherence Ctrl. Off	kHz	500	200
		Coherence Ctrl. On	MHz	40	
	SMSR (typ.)		dB		
	Signal to Total Source Spontaneous Emission Ratio <sup>*4</sup>		dB		
	Signal to Source Spontaneous Emission Ratio <sup>*5</sup>		dB/nm		

\* All specifications are quoted after 1 hour warm-up period. Specifications apply for wavelengths not equal to any water absorption line.

\*1: At static condition or "Step" sweep mode. \*2: For period of 1 hour. Within ±0.5 °C. \*3: At "Auto" power mode.

\*4: Ratio of signal power to total spontaneous emission power within ±15nm of the signal wavelength (typical value).

\*5: Ratio of signal power to maximum spontaneous emission power in a 1nm band within a ±3nm band around the signal wavelength (typical value).

\*6: At maximum output power. \*7: Warrant range is 1560 to 1650nm





## General specifications

Interface	Optical Output Connector	-	FC or SC, SPC or APC	
	Optical Fiber	-	SMF or PMF <sup>*1</sup>	
	Communication	-	GP-IB (IEEE 488.2), USB, RS-232C	
	Power Monitor	V	0 to 3	
Modulation	LF Modulation	kHz	DC to 400 (Input level -2 to 0V, Modulation depth >50%/V (typ.))	
	RF Modulation (option)	MHz	2 to 100 (Input level 5Vp-p, Modulation depth >10% (typ.))	
Environmental Conditions and others	Operating	Temperature	degC	
		Humidity	%	
	Power Supply	-	AC 100-240V±10%, 50/60Hz	
	Power Consumption	VA	100	
	Dimensions (W) x (D) x (H)	mm	210x440x110	
Weight	kg	6.5		

\*1: In case of PMF, Polarization axis in alignment with connector key, Polarization extinction ratio is 17dB (typical value).

# SANTEC TUNABLE LASERS

## Model selection

Model Number	Wavelength Range
260360	1260  1360
355485	1355  1485
480630	1480  1630
500630	1500  1630
560680	1560  1680

Other wavelength range model is available on request. Please contact Santec Sales.

## Laser safety information



This product is classified class 1M laser product according to IEC 60825-1 (2007). This product complies with FDA performance standards for laser products except for deviations pursuant to Laser Notice No. 50 dated June 24, 2007.

## Ordering Code

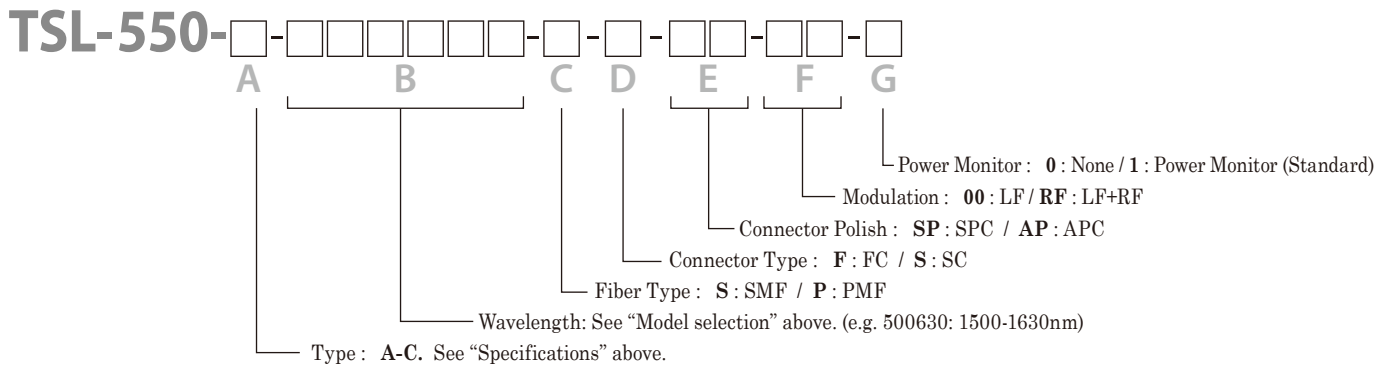

[www.santec.com](http://www.santec.com) E-Mail : [sales@santec.com](mailto:sales@santec.com)



**SANTEC CORPORATION**  
5823 Ohkusa-Nenjyozaka, Komaki, Aichi 485-0802, Japan Tel. +81-568-79-3536 Fax +81-568-79-1718

**SANTEC U.S.A. CORPORATION**  
433 Hackensack Ave., Hackensack, NJ, 07601, U.S.A. Toll Free +1-800-726-8321 (santec-1) Tel. +1-201-488-5505 Fax +1-201-488-7702

**SANTEC EUROPE LIMITED**  
1 Lyric Square, London, W6 0NB, U.K. Tel. +44-20-3542-7851

**SANTEC (SHANGHAI) Co., Ltd.**  
11F Room E, Hua Du Bldg., No.838 Zhangyang Road, Pudong District, Shanghai 200122 China Tel: +86-21-58361261, +86-21-58361262 Fax: +86-21-58361263